



- High Accuracy
- Broad Bandwidth
- Low Zero-drift

Shenzhen Hangzhi Precision Electronics Co. Ltd.

AIT3000-SG High-Precision Current Transducer

AIT3000-SG has a high gain and measurement accuracy in the full bandwidth range, due to the application of the multi-point zero-flux technology system and high-frequency ripple sensing channel on top of currently existing DC sensor technology.

The multi-point zero-flux technology system secures the high accuracy by utilizing the technology combination of exciting magnetic flux closed-loop control, self-excited magnetic flux gate and multi-closed-loop control that realizes the closed-loop control between excitation magnetic flux and AC/DC magnetic flux generated by primary current, while the high-frequency ripple sensing channel allows the sensor to have the high performance over the full bandwidth range.

Product photo



SHENZHEN HANGZHI PRECISION ELECTRONICS CO. LTD

Add: Rm 531, Building B, Huayuan Hi-Tech Innovation Park,
Baoyuan Road, Bao'an District, Shenzhen, China P.R.
Email: sales@hangzhicn.com Technical support: info@hangzhicn.com
Tel: +86(0)755-8259 3440 Website: www.hangzhicn.com



- High Accuracy
- Broad Bandwidth
- Low Zero-drift

Shenzhen Hangzhi Precision Electronics Co. Ltd.

Key Technologies

- ◇ Excitation closed-loop control technology
- ◇ Self-excitation demagnetization technology
- ◇ Multi-point zero-flux technology
- ◇ Temperature control compensation technology
- ◇ Multi-range automatic switching technology

Features

- ◇ Insulated measurement between primary and secondary side
- ◇ Excellent linearity and accuracy
- ◇ Extremely low temperature drift
- ◇ Extremely low zero drift
- ◇ Broad band and low response time
- ◇ Strong anti-electromagnetic interference

Application Domain

- ◇ Medical Equipment: Scanner, MRI
- ◇ Power industry: Converter, Inverter
- ◇ Renewable Energy: Photovoltaic, Wind energy
- ◇ Testing Instrument: Power analyzer, High-precision power supply
- ◇ Smart Power Grid: Power generation and battery monitoring, Medium low voltage substation
- ◇ Industry Control: Industrial motor drive, UPS, Welding, Robot, Hoist, Elevator, Ski lift
- ◇ Rail Transit: EMU, Metro, Trolley car
- ◇ Ship: Electric driven ship
- ◇ Car: Electric car

Electrical Performance

Parameter	Symbol	Measuring Conditions	Min	Typ	Max	Unit
Primary nominal direct current	I_{PN_DC}	—	—	±3000	3300	Adc
Primary nominal alternating current*	I_{PN}	—	—	2121	2333	Aac
Operating voltage	V_C	—	—	220	—	Vac
Power consumption current	I_{PWR}	Rated primary current	—	—	210	mA
Current ratio	K_N	Input : Output	3000:1	3000:1	3000:1	—
Rated output current	I_{SN}	Rated Primary current	—	±1.0	—	A
Measuring resistance	R_M		0	1	1.5	Ω

* refers to AC effective value

SHENZHEN HANGZHI PRECISION ELECTRONICS CO. LTD

Add: Rm 531, Building B, Huayuan Hi-Tech Innovation Park,
Baoyuan Road, Bao'an District, Shenzhen, China P.R.
Email: sales@hangzhicn.com Technical support: info@hangzhicn.com
Tel: +86(0)755-8259 3440 Website: www.hangzhicn.com



- High Accuracy
- Broad Bandwidth
- Low Zero-drift

Shenzhen Hangzhi Precision Electronics Co. Ltd.

Accuracy Measurement

Parameter	Symbol	Measuring Conditions	Min	Typ	Max	Unit
Accuracy	X _G	Input direct current, 25±20°C	—	—	50	ppm
Linearity	ε _L	—	—	—	30	ppm
Temperature stability	T _C	—	—	—	0.1	ppm/K
Time stability	T _T	—	—	—	0.2	ppm/month
Power supply interference	T _V	—	—	—	1	ppm/V
Zero offset current	I _O	@25°C	—	—	1 (can be adjusted to zero by users)	ppm
Ripple current	I _N	DC-10Hz	—	—	0.5	ppm
Dynamic response time	t _r	di/dt=100A/us, rised to 90%I _{PN}	—	—	1	us
Current change rate	di/dt	—	100	—	—	A/us
Frequency bandwidth (-3dB)	F	—	0	—	300	kHz
Zero offset current	I _{OT}	Full temperature range	—	—	±5	μA

Safety Characteristics

Parameter	Symbol	Measuring Conditions	Value	Unit
Insulation voltage / Between primary and secondary sides	V _d	50Hz, 1min	5	KV
Transient isolation withstand voltage / Between primary and secondary sides	V _w	50us	10	KV
Creepage distance / Between the primary and the outer shell	d _{Cp}	—	11	mm
Clearance distance / Between the primary and the outer shell	d _{ci}	—	11	mm
Comparative tracking index	CTI	IEC-60112	600	V

General Characteristics

Parameter	Symbol	Measuring Condition	Min	Typ	Max	Unit
Ambient operating temperature	T _A	—	-40	—	+85	°C
Mass	M	—	—	17500±200	—	g

SHENZHEN HANGZHI PRECISION ELECTRONICS CO. LTD

Add: Rm 531, Building B, Huayuan Hi-Tech Innovation Park,
Baoyuan Road, Bao'an District, Shenzhen, China P.R.
Email: sales@hangzhicn.com Technical support: info@hangzhicn.com
Tel: +86(0)755-8259 3440 Website: www.hangzhicn.com



- High Accuracy
- Broad Bandwidth
- Low Zero-drift

Shenzhen Hangzhi Precision Electronics Co. Ltd.

Operating Status Instructions

◇ Normal status:

The green indicator is on when the device is running normally.

◇ Fault status:

The green light will be off when the transducer is in fault mode.

Trouble-shooting:

- a) When the green light is off, the power supply should be checked as the first step;
- b) If the power supply is normal, then the primary current is over the specified measurement range and the transducers will be in overload mode.

In this mode, the transducers will be working in non-zero flux mode, that the secondary current remains at specified maximum output, the secondary and primary currents are not in proportional. When the measuring current returns to the specified measurement range, the output current will return to normal and the green light will be on.

Instructions

The steps are as follows:

Step 1: Connect the transducer and the control box through a dedicated connection line.

Step 2: Insert the AC 220V power plug into the control box and turn on the power supply switch

Step 3: Pass the current cable to be tested through the transducer and pay attention to the current direction.

Step 4: The current output interface is connected to the current measuring instrument or current sampling circuit. Note that the sampling resistance value cannot exceed the maximum limit value.

Connection System

1. Control box power supply wiring:

The power interface of the control box is directly connected to the 220V power supply;

Red terminal: the positive side of the secondary current output;

Black terminal: the negative side of the secondary current output;

2. Connection of control box and winding coil

Insert the D-Sub9 male connector on the winding coil directly into the D-Sub9 female connector of the control box and fix it with screws.

3. Test description:

By measuring the test current I_S flowing through R_M , or the voltage U_R across R_M ,

The primary current I_P can be obtained:

$$I_P = K_N * I_S = K_N * (U_R / R_M)$$

SHENZHEN HANGZHI PRECISION ELECTRONICS CO. LTD

Add: Rm 531, Building B, Huayuan Hi-Tech Innovation Park,

Baoyuan Road, Bao'an District, Shenzhen, China P.R.

Email: sales@hangzhicn.com Technical support: info@hangzhicn.com

Tel: +86(0)755-8259 3440 Website: www.hangzhicn.com



- High Accuracy
- Broad Bandwidth
- Low Zero-drift

Shenzhen Hangzhi Precision Electronics Co. Ltd.

Dimensions of Control Box

Unit: mm

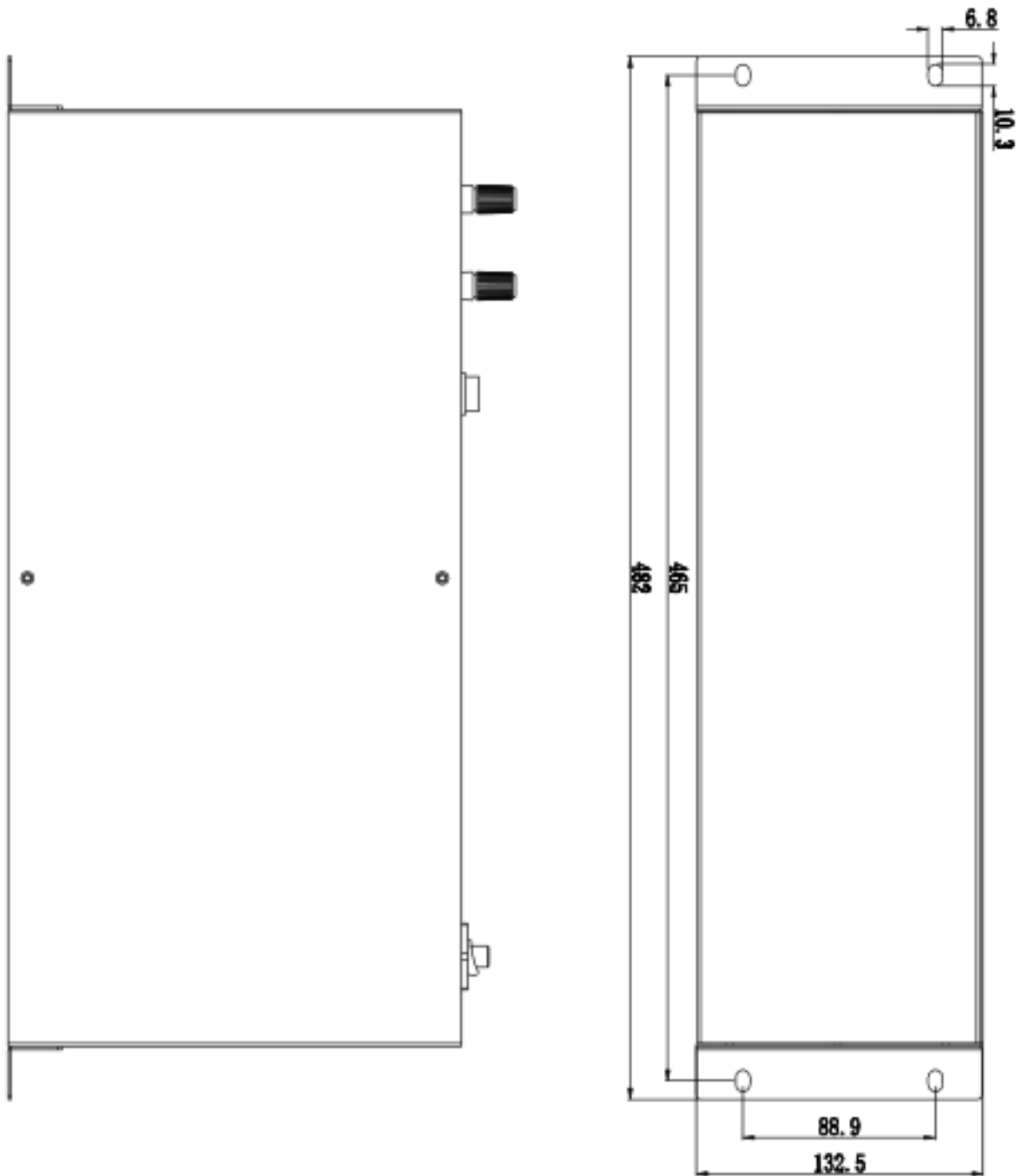



- High Accuracy
- Broad Bandwidth
- Low Zero-drift

Shenzhen Hangzhi Precision Electronics Co. Ltd.

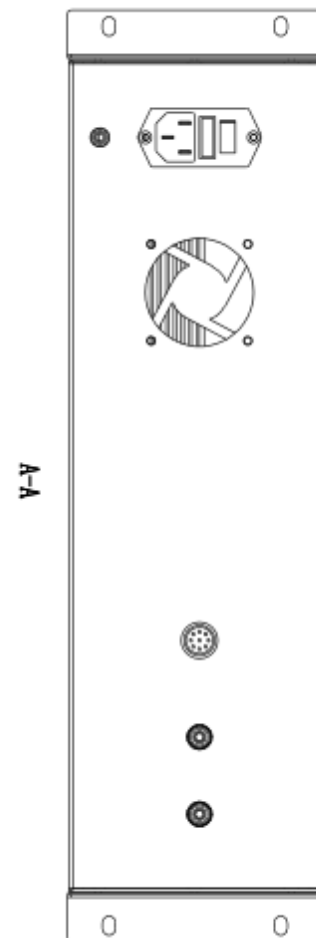
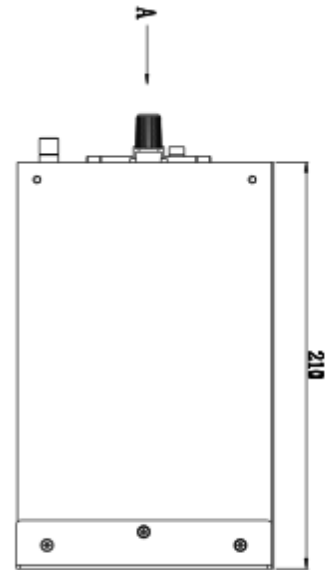
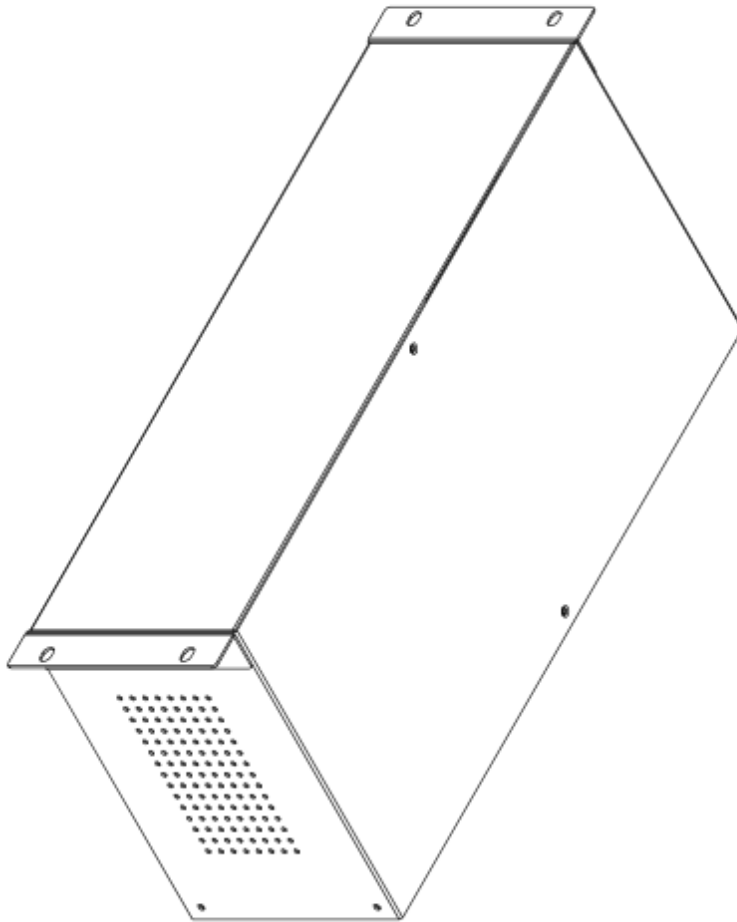



- High Accuracy
- Broad Bandwidth
- Low Zero-drift

Shenzhen Hangzhi Precision Electronics Co. Ltd.

Dimensions of Current Transducer

Unit: mm

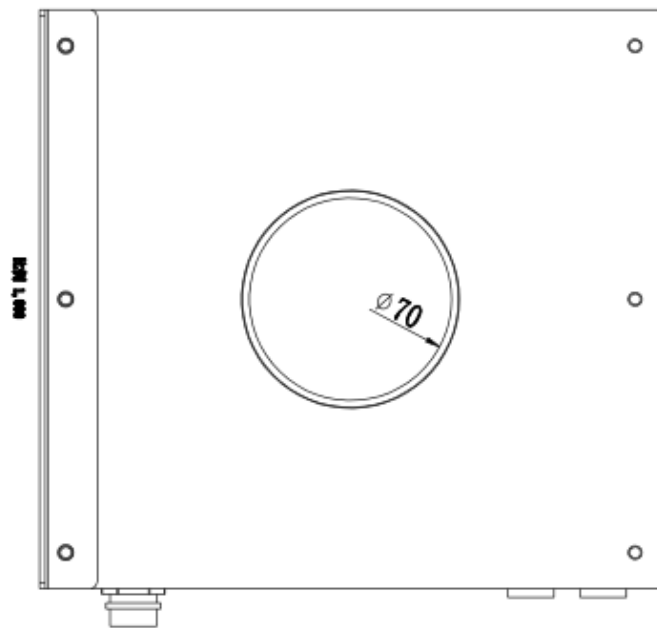
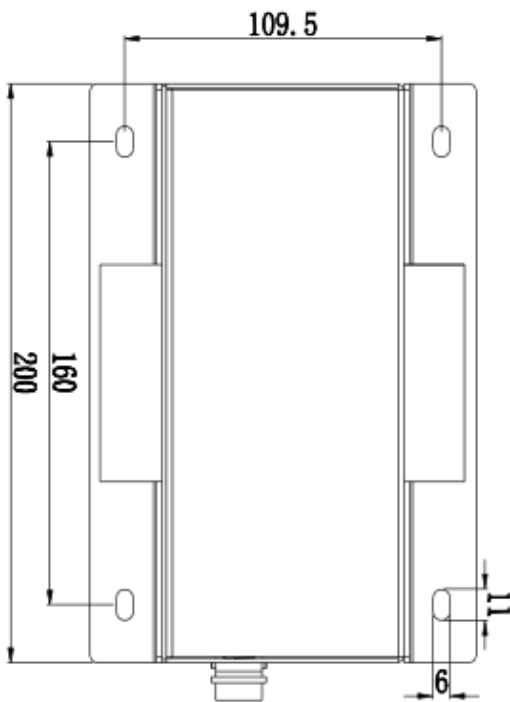
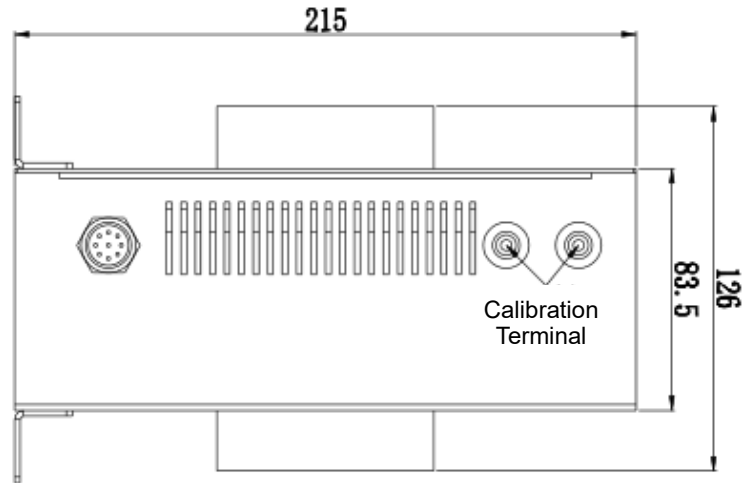

SHENZHEN HANGZHI PRECISION ELECTRONICS CO. LTD

Add: Rm 531, Building B, Huayuan Hi-Tech Innovation Park,
Baoyuan Road, Bao'an District, Shenzhen, China P.R.
Email: sales@hangzhicn.com Technical support: info@hangzhicn.com
Tel: +86(0)755-8259 3440 Website: www.hangzhicn.com



- High Accuracy
- Broad Bandwidth
- Low Zero-drift

Shenzhen Hangzhi Precision Electronics Co. Ltd.

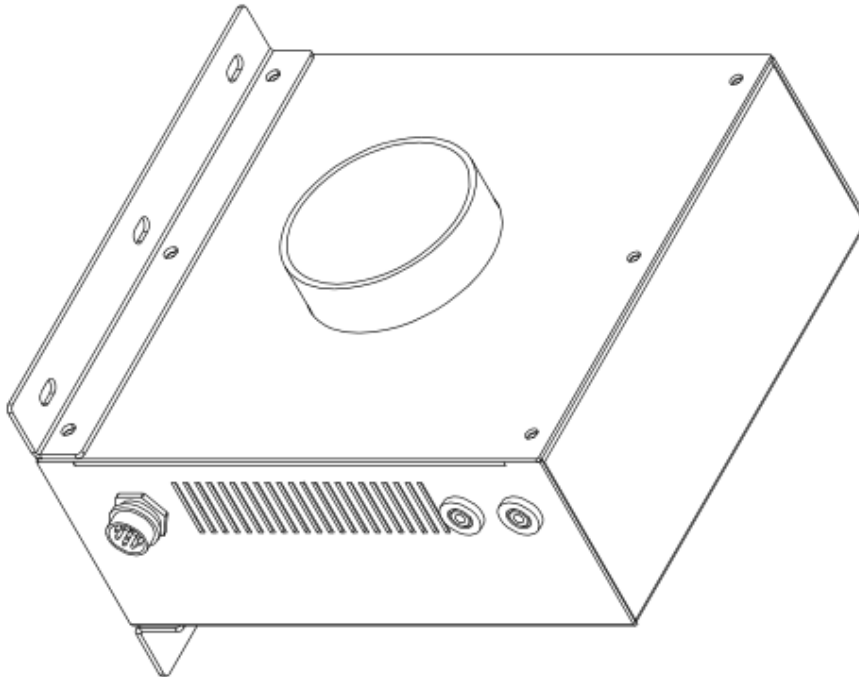
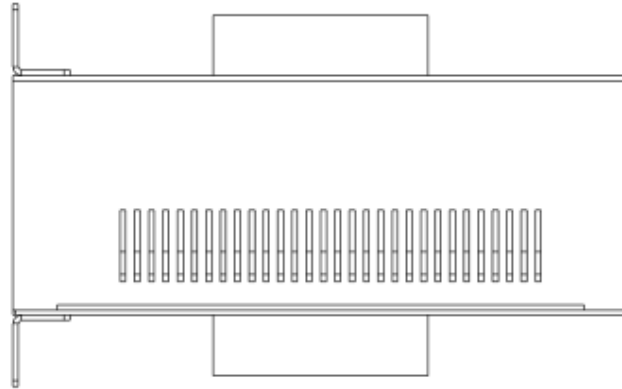

SHENZHEN HANGZHI PRECISION ELECTRONICS CO. LTD

Add: Rm 531, Building B, Huayuan Hi-Tech Innovation Park,
Baoyuan Road, Bao'an District, Shenzhen, China P.R.
Email: sales@hangzhicn.com Technical support: info@hangzhicn.com
Tel: +86(0)755-8259 3440 Website: www.hangzhicn.com